

終止販賣通知**HS5E 型 電磁式安全開關**

茲因 HS5E 型電磁式安全開關即將停產，特此通知。(2018 年 1 月已發行停產預告：通知函編號 T-2017028)

實 施 期 間

- 最後訂購日：2019 年 3 月 29 日
- 最後出貨日：2019 年 6 月 28 日

※即使在實施期間之前，若庫存用盡時，將提前結束最後訂購。

對 象 機 種

HS5E 型 電磁式安全開關 全機種

※包含以標準品為基礎的客製化製品。

但是，不包含 HS5E-K 型 鑰匙鎖定型安全開關。

詳細型號請參閱附件 1【機種一覽表】

**推 薦 替 代 品**

推薦使用 HS5L 型 電磁式安全開關。

詳細說明請參閱附件 2【停產品及替代品對照表(詳細)】。

終 止 販 賣 的 理 由

為了對應規格和市場動向的變化，以及為了提高生產率以及製品供給的安定性。

替 代 時 的 注 意 事 項

1. HS5L 型僅彈簧壓接式端子台型。使用時請自行準備電纜。
2. 因為 HS5L 型的門監控接點以及鎖定監控接點在內部並未連接，所以若欲使用跟現行的 HS5E 型相同回路的話，一部分的端子間將必須短路。

3. HS5L 型為小形化設計，具有 ISO14119 的無效化防止效果，但是安裝孔位置、手動鎖定解除、LED 位置均與 HS5E 型不同。若希望與 HS5E 型的孔位相同，請使用側面電纜引出型。

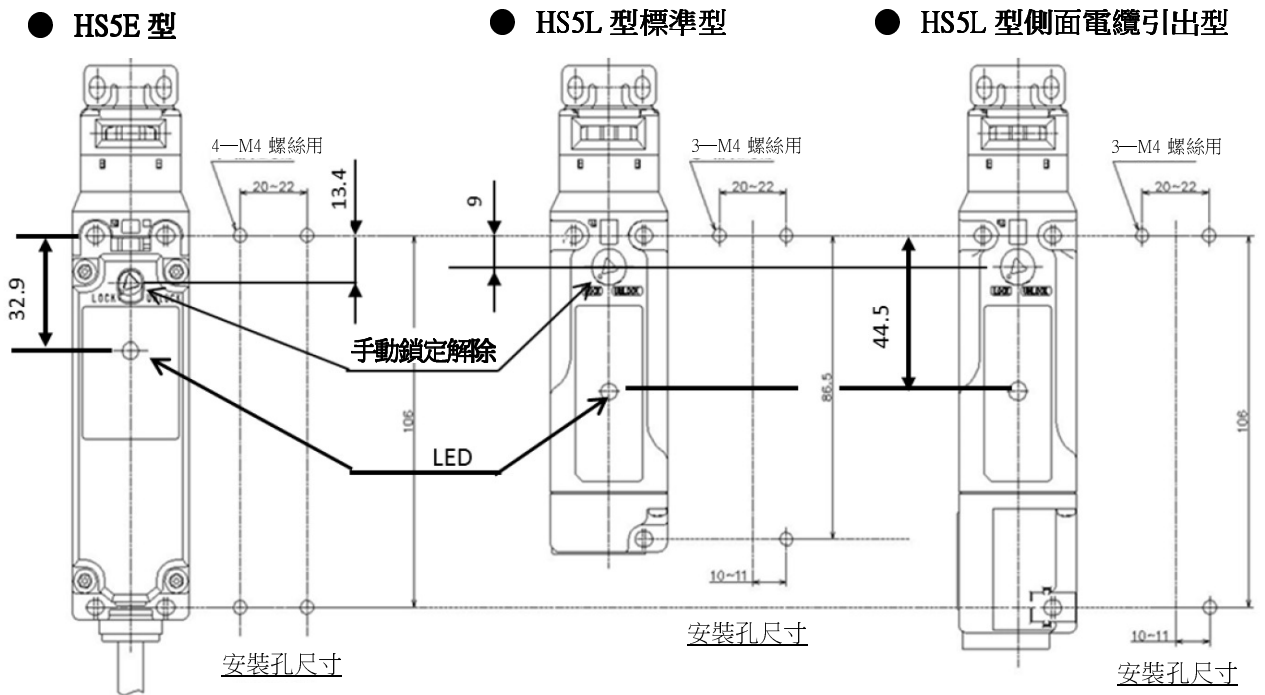

4. 背面鎖定解除按鈕用的孔位置、尺寸不同。

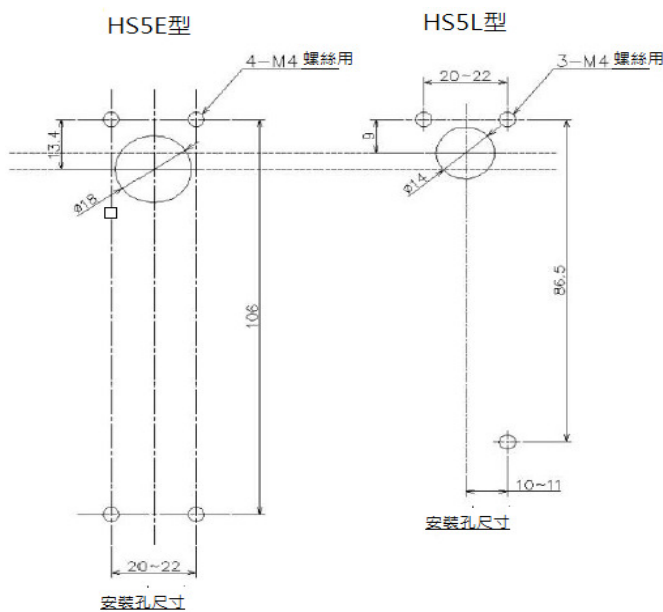

※其他若有不清楚的地方，請洽 IDEC 業務人員。

終止販賣的理由

為提高生產率以及製品供給的安定性，故終止販賣上述製品。
若有不清楚的地方，請洽 IDEC 業務人員。

項次	販賣終止機種	替代品機種	
		標準型	側面電纜引出型
1	HS5E-A4001	HS5L-VA44M-G	HS5L-VA44SM-G
2	HS5E-A4003	HS5L-VA44M-G	HS5L-VA44SM-G
3	HS5E-A4005	HS5L-VA44M-G	HS5L-VA44SM-G
4	HS5E-A4401-G	HS5L-VA44M-G	HS5L-VA44SM-G
5	HS5E-A4403-G	HS5L-VA44M-G	HS5L-VA44SM-G
6	HS5E-A4405-G	HS5L-VA44M-G	HS5L-VA44SM-G
7	HS5E-B4001	HS5L-VB44M-G	-
8	HS5E-B4003	HS5L-VB44M-G	-
9	HS5E-B4005	HS5L-VB44M-G	-
10	HS5E-B4401-G	HS5L-VB44M-G	-
11	HS5E-B4403-G	HS5L-VB44M-G	-
12	HS5E-B4405-G	HS5L-VB44M-G	-
13	HS5E-C4001	HS5L-VC44M-G	-
14	HS5E-C4003	HS5L-VC44M-G	-
15	HS5E-C4005	HS5L-VC44M-G	-
16	HS5E-C4401-G	HS5L-VC44M-G	-
17	HS5E-C4401-G-TK2408	HS5L-VC44M-G	-
18	HS5E-C4403-G	HS5L-VC44M-G	-
19	HS5E-C4405-G	HS5L-VC44M-G	-
20	HS5E-D4001	HS5L-VD44M-G	HS5L-VD44SM-G
21	HS5E-D4003	HS5L-VD44M-G	HS5L-VD44SM-G
22	HS5E-D4003-TK2408	HS5L-VD44M-G	HS5L-VD44SM-G
23	HS5E-D4005	HS5L-VD44M-G	HS5L-VD44SM-G
24	HS5E-D4401-G	HS5L-VD44M-G	HS5L-VD44SM-G
25	HS5E-D4403-G	HS5L-VD44M-G	HS5L-VD44SM-G
26	HS5E-D4403-G-TK2408	HS5L-VD44M-G	HS5L-VD44SM-G
27	HS5E-D4405-G	HS5L-VD44M-G	HS5L-VD44SM-G
28	HS5E-D4410-G	HS5L-VD44M-G	HS5L-VD44SM-G
29	HS5E-D4410-G-TK2408	HS5L-VD44M-G	HS5L-VD44SM-G
30	HS5E-D4415-G	HS5L-VD44M-G	HS5L-VD44SM-G
31	HS5E-F4001	HS5L-VF44M-G	HS5L-VF44SM-G
32	HS5E-F4003	HS5L-VF44M-G	HS5L-VF44SM-G
33	HS5E-F4005	HS5L-VF44M-G	HS5L-VF44SM-G
34	HS5E-F4401-G	HS5L-VF44M-G	HS5L-VF44SM-G
35	HS5E-F4401-G-TK2408	HS5L-VF44M-G	HS5L-VF44SM-G
36	HS5E-F4403-G	HS5L-VF44M-G	HS5L-VF44SM-G
37	HS5E-F4405-G	HS5L-VF44M-G	HS5L-VF44SM-G
38	HS5E-G4001	HS5L-VG44M-G	-
39	HS5E-G4003	HS5L-VG44M-G	-
40	HS5E-G4005	HS5L-VG44M-G	-
41	HS5E-G4401-G	HS5L-VG44M-G	-
42	HS5E-G4401-G-TK2408	HS5L-VG44M-G	-
43	HS5E-G4403-G	HS5L-VG44M-G	-
44	HS5E-G4405-G	HS5L-VG44M-G	-
45	HS5E-H4001	無直接替代品、請考慮 HS5L-VJ44M-G	
46	HS5E-H4003	無直接替代品、請考慮 HS5L-VJ44M-G	
47	HS5E-H4005	無直接替代品、請考慮 HS5L-VJ44M-G	
48	HS5E-H4401-G	無直接替代品、請考慮 HS5L-VJ44M-G	
49	HS5E-H4403-G	無直接替代品、請考慮 HS5L-VJ44M-G	
50	HS5E-H4405-G	無直接替代品、請考慮 HS5L-VJ44M-G	

項次	販賣終止機種	替代品機種	
		標準型	側面電纜引出型
51	HS5E-J4001	HS5L-VJ44M-G	-
52	HS5E-J4003	HS5L-VJ44M-G	-
53	HS5E-J4005	HS5L-VJ44M-G	-
54	HS5E-J4401-G	HS5L-VJ44M-G	-
55	HS5E-J4403-G	HS5L-VJ44M-G	-
56	HS5E-J4405-G	HS5L-VJ44M-G	-
57	HS5E-A7Y001	HS5L-VA7Y4M-G	HS5L-VA7Y4SM-G
58	HS5E-A7Y001-TK2408	HS5L-VA7Y4M-G	HS5L-VA7Y4SM-G
59	HS5E-A7Y003	HS5L-VA7Y4M-G	HS5L-VA7Y4SM-G
60	HS5E-A7Y005	HS5L-VA7Y4M-G	HS5L-VA7Y4SM-G
61	HS5E-A7Y401-G	HS5L-VA7Y4M-G	HS5L-VA7Y4SM-G
62	HS5E-A7Y403-G	HS5L-VA7Y4M-G	HS5L-VA7Y4SM-G
63	HS5E-A7Y405-G	HS5L-VA7Y4M-G	HS5L-VA7Y4SM-G
64	HS5E-B7Y001	HS5L-VB7Y4M-G	-
65	HS5E-B7Y003	HS5L-VB7Y4M-G	-
66	HS5E-B7Y005	HS5L-VB7Y4M-G	-
67	HS5E-B7Y401-G	HS5L-VB7Y4M-G	-
68	HS5E-B7Y403-G	HS5L-VB7Y4M-G	-
69	HS5E-B7Y405-G	HS5L-VB7Y4M-G	-
70	HS5E-C7Y001	HS5L-VC7Y4M-G	HS5L-VC7Y4SM-G
71	HS5E-C7Y003	HS5L-VC7Y4M-G	HS5L-VC7Y4SM-G
72	HS5E-C7Y005	HS5L-VC7Y4M-G	HS5L-VC7Y4SM-G
73	HS5E-C7Y401-G	HS5L-VC7Y4M-G	HS5L-VC7Y4SM-G
74	HS5E-C7Y401-G-TK2408	HS5L-VC7Y4M-G	HS5L-VC7Y4SM-G
75	HS5E-C7Y401-G-TK2406-KR	HS5L-VC7Y4M-G	HS5L-VC7Y4SM-G
76	HS5E-C7Y403-G	HS5L-VC7Y4M-G	HS5L-VC7Y4SM-G
77	HS5E-C7Y405-G	HS5L-VC7Y4M-G	HS5L-VC7Y4SM-G
78	HS5E-D7Y001	HS5L-VD7Y4M-G	-
79	HS5E-D7Y003	HS5L-VD7Y4M-G	-
80	HS5E-D7Y005	HS5L-VD7Y4M-G	-
81	HS5E-D7Y401-G	HS5L-VD7Y4M-G	-
82	HS5E-D7Y403-G	HS5L-VD7Y4M-G	-
83	HS5E-D7Y405-G	HS5L-VD7Y4M-G	-
84	HS5E-F7Y001	HS5L-VF7Y4M-G	HS5L-VF7Y4SM-G
85	HS5E-F7Y003	HS5L-VF7Y4M-G	HS5L-VF7Y4SM-G
86	HS5E-F7Y005	HS5L-VF7Y4M-G	HS5L-VF7Y4SM-G
87	HS5E-F7Y005-TK2972	HS5L-VF7Y4M-G	HS5L-VF7Y4SM-G
88	HS5E-F7Y401-G	HS5L-VF7Y4M-G	HS5L-VF7Y4SM-G
89	HS5E-F7Y401-G-TK2408	HS5L-VF7Y4M-G	HS5L-VF7Y4SM-G
90	HS5E-F7Y403-G	HS5L-VF7Y4M-G	HS5L-VF7Y4SM-G
91	HS5E-F7Y405-G	HS5L-VF7Y4M-G	HS5L-VF7Y4SM-G
92	HS5E-G7Y001	HS5L-VG7Y4M-G	HS5L-VG7Y4SM-G
93	HS5E-G7Y003	HS5L-VG7Y4M-G	HS5L-VG7Y4SM-G
94	HS5E-G7Y005	HS5L-VG7Y4M-G	HS5L-VG7Y4SM-G
95	HS5E-G7Y401-G	HS5L-VG7Y4M-G	HS5L-VG7Y4SM-G
96	HS5E-G7Y401-G-TK2408	HS5L-VG7Y4M-G	HS5L-VG7Y4SM-G
97	HS5E-G7Y403-G	HS5L-VG7Y4M-G	HS5L-VG7Y4SM-G
98	HS5E-G7Y405-G	HS5L-VG7Y4M-G	HS5L-VG7Y4SM-G
99	HS5E-H7Y001	無直接替代品、請考慮 HS5L-VJ7Y4M-G	
100	HS5E-H7Y003	無直接替代品、請考慮 HS5L-VJ7Y4M-G	

項次	販賣終止機種	替代品機種	
		標準型	側面電纜引出型
101	HS5E-H7Y005	無直接替代品、請考慮 HS5L-VJ7Y4M-G	
102	HS5E-H7Y401-G	無直接替代品、請考慮 HS5L-VJ7Y4M-G	
103	HS5E-H7Y403-G	無直接替代品、請考慮 HS5L-VJ7Y4M-G	
104	HS5E-H7Y405-G	無直接替代品、請考慮 HS5L-VJ7Y4M-G	
105	HS5E-J7Y001	HS5L-VJ7Y4M-G	-
106	HS5E-J7Y003	HS5L-V J 7Y4M-G	-
107	HS5E-J7Y005	HS5L-V J 7Y4M-G	-
108	HS5E-J7Y401-G	HS5L-V J 7Y4M-G	-
109	HS5E-J7Y403-G	HS5L-V J 7Y4M-G	-
110	HS5E-J7Y405-G	HS5L-V J 7Y4M-G	-
111	HS5E-A44L01-G	HS5L-VA44LM-G	-
112	HS5E-A44L03-G	HS5L-VA44LM-G	-
113	HS5E-A44L05-G	HS5L-VA44LM-G	-
114	HS5E-C44L01-G	HS5L-VC44LM-G	-
115	HS5E-C44L03-G	HS5L-VC44LM-G	-
116	HS5E-C44L05-G	HS5L-VC44LM-G	-
117	HS5E-D44L01-G	HS5L-VD44LM-G	HS5L-VD44LSM-G
118	HS5E-D44L01-G-TK2445	HS5L-VD44LM-G	HS5L-VD44LSM-G
119	HS5E-D44L03-G	HS5L-VD44LM-G	HS5L-VD44LSM-G
120	HS5E-D44L05-G	HS5L-VD44LM-G	HS5L-VD44LSM-G
121	HS5E-F44L01-G	HS5L-VD44LM-G	HS5L-VD44LSM-G
122	HS5E-F44L03-G	HS5L-VD44LM-G	HS5L-VD44LSM-G
123	HS5E-F44L05-G	HS5L-VD44LM-G	HS5L-VD44LSM-G
124	HS5E-G44L01-G	HS5L-VB44LM-G	-
125	HS5E-G44L03-G	HS5L-VB44LM-G	-
126	HS5E-G44L05-G	HS5L-VB44LM-G	-
127	HS5E-G40L05-G-TK2445	HS5L-VB44LM-G	-
128	HS5E-DD4401-G	HS5L-DD44M-G	HS5L-DD44SM-G
129	HS5E-DD4403-G	HS5L-DD44M-G	HS5L-DD44SM-G
130	HS5E-DD4405-G	HS5L-DD44M-G	HS5L-DD44SM-G
131	HS5E-DD4410-G	HS5L-DD44M-G	HS5L-DD44SM-G
132	HS5E-DD4415-G	HS5L-DD44M-G	HS5L-DD44SM-G
133	HS5E-DD44L01-G	HS5L-DD44LM-G	HS5L-DD44LSM-G
134	HS5E-DD44L03-G	HS5L-DD44LM-G	HS5L-DD44LSM-G
135	HS5E-DD44L05-G	HS5L-DD44LM-G	HS5L-DD44LSM-G
136	HS5E-DD44L10-G	HS5L-DD44LM-G	HS5L-DD44LSM-G
137	HS5E-DD44L15-G	HS5L-DD44LM-G	HS5L-DD44LSM-G
138	HS5E-VA4401-G	HS5L-VA44M-G	HS5L-VA44SM-G
139	HS5E-VA4403-G	HS5L-VA44M-G	HS5L-VA44SM-G
140	HS5E-VA4405-G	HS5L-VA44M-G	HS5L-VA44SM-G
141	HS5E-VB4401-G	HS5L-VB44M-G	-
142	HS5E-VB4403-G	HS5L-VB44M-G	-
143	HS5E-VB4405-G	HS5L-VB44M-G	-
144	HS5E-VC4401-G	HS5L-VC44M-G	-
145	HS5E-VC4403-G	HS5L-VC44M-G	-
146	HS5E-VC4405-G	HS5L-VC44M-G	-
147	HS5E-VD4401-G	HS5L-VD44M-G	HS5L-VD44SM-G
148	HS5E-VD4403-G	HS5L-VD44M-G	HS5L-VD44SM-G
149	HS5E-VD44045-G-TK2980	HS5L-VD44M-G	HS5L-VD44SM-G
150	HS5E-VD4405-G	HS5L-VD44M-G	HS5L-VD44SM-G

項次	販賣終止機種	替代品機種	
		標準型	側面電纜引出型
151	HS5E-VF4401-G	HS5L-VF44M-G	-
152	HS5E-VF4405-G	HS5L-VF44M-G	-
153	HS5E-VA7Y401-G	HS5L-VA7Y4M-G	HS5L-VA7Y4SM-G
154	HS5E-VA7Y403-G	HS5L-VA7Y4M-G	HS5L-VA7Y4SM-G
155	HS5E-VA7Y405-G	HS5L-VA7Y4M-G	HS5L-VA7Y4SM-G
156	HS5E-VB7Y401-G	HS5L-VB7Y4M-G	-
157	HS5E-VB7Y403-G	HS5L-VB7Y4M-G	-
158	HS5E-VB7Y405-G	HS5L-VB7Y4M-G	-
159	HS5E-VC7Y401-G	HS5L-VC7Y4M-G	HS5L-VC7Y4SM-G
160	HS5E-VC7Y403-G	HS5L-VC7Y4M-G	HS5L-VC7Y4SM-G
161	HS5E-VC7Y405-G	HS5L-VC7Y4M-G	HS5L-VC7Y4SM-G
162	HS5E-VD7Y401-G	HS5L-VD7Y4M-G	HS5L-VD7Y4SM-G
163	HS5E-VD7Y403-G	HS5L-VD7Y4M-G	HS5L-VD7Y4SM-G
164	HS5E-VD7Y405-G	HS5L-VD7Y4M-G	HS5L-VD7Y4SM-G
165	HS5E-VD7Y405-G-TK2686	HS5L-VD7Y4M-G	HS5L-VD7Y4SM-G
166	HS5E-VF7Y401-G	HS5L-VF7Y4M-G	HS5L-VF7Y4SM-G
167	HS5E-VF7Y403-G	HS5L-VF7Y4M-G	HS5L-VF7Y4SM-G

■T-2018048附件2【停產品及替代品對照表(詳細)】

• HSSE系列 標準型(彈簧鎖定型) 替代成→ HSSL系列 4接點型(彈簧鎖定型) 時

HSSE系列 (標準型、彈簧鎖定型)

回路編號	接點結構	指示燈	電纜長度	訂購型號
A	主回路:1NC+1NC、門監控回路:1NO、鎖定監控回路:1NO 主回路: ⊕11 12 41 42 輔助回路: ⊖23 24 輔助回路: 53 54	無	1m	HSSE-A4001
			3m	HSSE-A4003
			5m	HSSE-A4005
		有	1m	HSSE-A4401-G
			3m	HSSE-A4403-G
B	主回路:1NC+1NC、門監控回路:1NO、鎖定監控回路:1NC 主回路: ⊕11 12 41 42 輔助回路: ⊖23 24 輔助回路: 51 52	無	1m	HSSE-B4001
			3m	HSSE-B4003
			5m	HSSE-B4005
		有	1m	HSSE-B4401-G
			3m	HSSE-B4403-G
C	主回路:1NC+1NC、門監控回路:1NC、鎖定監控回路:1NO 主回路: ⊕11 12 41 42 輔助回路: ⊖21 22 輔助回路: 53 54	無	1m	HSSE-C4001
			3m	HSSE-C4003
			5m	HSSE-C4005
		有	1m	HSSE-C4401-G HSSE-C4401-G-TK2408
			3m	HSSE-C4403-G
D	主回路:1NC+1NC、門監控回路:1NC、鎖定監控回路:1NC 主回路: ⊕11 12 41 42 輔助回路: ⊖21 22 輔助回路: 51 52	無	1m	HSSE-D4001
			3m	HSSE-D4003 HSSE-D4003-TK2408
			5m	HSSE-D4005
		有	1m	HSSE-D4401-G
			3m	HSSE-D4403-G HSSE-D4403-G-TK2408
F	主回路:1NC+1NC、門監控回路:2NC 主回路: ⊕11 12 41 42 輔助回路: ⊖21 22 輔助回路: ⊖31 32	無	1m	HSSE-F4001
			3m	HSSE-F4003
			5m	HSSE-F4005
		有	1m	HSSE-F4401-G HSSE-F4401-G-TK2408
			3m	HSSE-F4403-G
G	主回路:1NC+1NC、門監控回路:1NC, 1NO 主回路: ⊕11 12 41 42 輔助回路: ⊖21 22 輔助回路: 33 34	無	1m	HSSE-G4001
			3m	HSSE-G4003
			5m	HSSE-G4005
		有	1m	HSSE-G4401-G HSSE-G4401-G-TK2408
			3m	HSSE-G4403-G
H	主回路:1NC+1NC、門監控回路:2NC 主回路: ⊕11 12 41 42 輔助回路: 51 52 輔助回路: 61 62	無	1m	HSSE-H4001
			3m	HSSE-H4003
			5m	HSSE-H4005
		有	1m	HSSE-H4401-G
			3m	HSSE-H4403-G
J	主回路:1NC+1NC、門監控回路:1NC, 1NO 主回路: ⊕11 12 41 42 輔助回路: 51 52 輔助回路: 63 64	無	1m	HSSE-J4001
			3m	HSSE-J4003
			5m	HSSE-J4005
		有	1m	HSSE-J4401-G
			3m	HSSE-J4403-G

替代機種 HSSL系列 (4接點型、彈簧鎖定型)

回路編號	接點結構	指示燈	導管口尺寸	訂購型號	備註(1)
VA	門監控回路:1NC, 1NO 鎖定監控回路:1NC, 1NO 輔助回路: ⊕11 12 41 42 ⊕ (備註2) 輔助回路: ⊖23 24 輔助回路: 53 54	有	M20	HS5L-VA44M-G HS5L-VA44SM-G (側面電纜引出型)	端子12-41未連接
VB	門監控回路:1NC, 1NO 鎖定監控回路:2NC 輔助回路: ⊕11 12 41 42 ⊕ (備註2) 輔助回路: ⊖23 24 輔助回路: 51 52 ⊕ (備註2)	有	M20	HS5L-VB44M-G	端子12-41未連接
VC	門監控回路:2NC 鎖定監控回路:1NC, 1NO 輔助回路: ⊕11 12 41 42 ⊕ (備註2) 輔助回路: ⊖21 22 輔助回路: 53 54	有	M20	HS5L-VC44M-G	端子12-41未連接
VD	門監控回路:2NC 鎖定監控回路:2NC 輔助回路: ⊕11 12 41 42 ⊕ (備註2) 輔助回路: ⊖21 22 輔助回路: 51 52 ⊕ (備註2)	有	M20	HS5L-VD44M-G HS5L-VD44SM-G (側面電纜引出型)	端子12-41未連接
VF	門監控回路:3NC 鎖定監控回路:1NC 輔助回路: ⊕11 12 41 42 ⊕ (備註2) 輔助回路: ⊖21 22 輔助回路: ⊖31 32	有	M20	HS5L-VF44M-G HS5L-VF44SM-G (側面電纜引出型)	端子12-41未連接
VG	門監控回路:2NC, 1NO 鎖定監控回路:1NC 輔助回路: ⊕11 12 41 42 ⊕ (備註2) 輔助回路: ⊖21 22 輔助回路: 33 34	有	M20	HS5L-VG44M-G	端子12-41未連接
-	關於HSSE系列的回路編號「H」型，雖然接點結構稍有不同，請檢討採用HSSL系列的回路編號「VJ」型。				
VJ	門監控回路:1NC 鎖定監控回路:2NC, 1NO 輔助回路: ⊕11 12 41 42 ⊕ (備註2) 輔助回路: 51 52 ⊕ (備註2) 輔助回路: 63 64	有	M20	HS5L-VJ44M-G	端子12-41未連接

備註1: 若採用與HSSE型相同回路的話，請務必進行端子間的短路連接。

備註2: 根據ISO14119:2013， 輔助回路接點可單獨做為安全訊號。若採用HSSL型為替代機種時，最終頁的2接點型也請一併參考。

■T-2018048附件2【停產品及替代品對照表(詳細)】

· HSSE系列 標準型(電磁鎖定型) 替代成→ HSSL系列 4接點型(電磁鎖定型) 時

HSSE系列 (標準型、電磁鎖定型)

回路編號	接點結構	指示燈	電纜長度	訂購型號	
A	主回路:1NC+1NC、門監控回路:1NO、鎖定監控回路:1NO 主回路: 11, 12, 41, 42 輔助回路: 23, 24 輔助回路: 53, 54	無	1m	HSSE-A7Y001	
			3m	HSSE-A7Y003	
			5m	HSSE-A7Y005	
			有	1m	HSSE-A7Y401-G
				3m	HSSE-A7Y403-G
5m	HSSE-A7Y405-G				
B	主回路:1NC+1NC、門監控回路:1NO、鎖定監控回路:1NC 主回路: 11, 12, 41, 42 輔助回路: 23, 24 輔助回路: 51, 52	無	1m	HSSE-B7Y001	
			3m	HSSE-B7Y003	
			5m	HSSE-B7Y005	
			有	1m	HSSE-B7Y401-G
				3m	HSSE-B7Y403-G
5m	HSSE-B7Y405-G				
C	主回路:1NC+1NC、門監控回路:1NC、鎖定監控回路:1NO 主回路: 11, 12, 41, 42 輔助回路: 21, 22 輔助回路: 53, 54	無	1m	HSSE-C7Y001	
			3m	HSSE-C7Y003	
			5m	HSSE-C7Y005	
			有	1m	HSSE-C7Y401-G
				3m	HSSE-C7Y401-G-TK2408
5m	HSSE-C7Y401-G-TK2406-KR				
D	主回路:1NC+1NC、門監控回路:1NC、鎖定監控回路:1NC 主回路: 11, 12, 41, 42 輔助回路: 21, 22 輔助回路: 51, 52	無	1m	HSSE-D7Y001	
			3m	HSSE-D7Y003	
			5m	HSSE-D7Y005	
			有	1m	HSSE-D7Y401-G
				3m	HSSE-D7Y403-G
5m	HSSE-D7Y405-G				
F	主回路:1NC+1NC、門監控回路:2NC 主回路: 11, 12, 41, 42 輔助回路: 21, 22 輔助回路: 31, 32	無	1m	HSSE-F7Y001	
			3m	HSSE-F7Y003	
			5m	HSSE-F7Y005	
			有	1m	HSSE-F7Y005-TK2972
				3m	HSSE-F7Y401-G
5m	HSSE-F7Y401-G-TK2408				
G	主回路:1NC+1NC、門監控回路:1NC, 1NO 主回路: 11, 12, 41, 42 輔助回路: 21, 22 輔助回路: 33, 34	無	1m	HSSE-G7Y001	
			3m	HSSE-G7Y003	
			5m	HSSE-G7Y005	
			有	1m	HSSE-G7Y401-G
				3m	HSSE-G7Y401-G-TK2408
5m	HSSE-G7Y403-G				
H	主回路:1NC+1NC、門監控回路:2NC 主回路: 11, 12, 41, 42 輔助回路: 51, 52 輔助回路: 61, 62	無	1m	HSSE-H7Y001	
			3m	HSSE-H7Y003	
			5m	HSSE-H7Y005	
			有	1m	HSSE-H7Y401-G
				3m	HSSE-H7Y403-G
5m	HSSE-H7Y405-G				
J	主回路:1NC+1NC、門監控回路:1NC, 1NO 主回路: 11, 12, 41, 42 輔助回路: 51, 52 輔助回路: 63, 64	無	1m	HSSE-J7Y001	
			3m	HSSE-J7Y003	
			5m	HSSE-J7Y005	
			有	1m	HSSE-J7Y401-G
				3m	HSSE-J7Y403-G
5m	HSSE-J7Y405-G				

替代機種 HSSL系列 (4接點型、電磁鎖定型)

回路編號	接點結構	指示燈	導管口尺寸	訂購型號	備註(1)
VA	門監控回路:1NC, 1NO 鎖定監控回路:1NC, 1NO 輔助回路: 11, 12, 41, 42 (備註2) 輔助回路: 23, 24, 53, 54	有	M20	HSSL-VA7Y4M-G	端子12-41未連接
				HSSL-VA7Y4SM-G (側面電纜引出型)	
VB	門監控回路:1NC, 1NO 鎖定監控回路:2NC 輔助回路: 11, 12, 41, 42 (備註2) 輔助回路: 23, 24, 51, 52 (備註2)	有	M20	HSSL-VB7Y4M-G	端子12-41未連接
				HSSL-VB7Y4SM-G (側面電纜引出型)	
VC	門監控回路:2NC 鎖定監控回路:1NC, 1NO 輔助回路: 11, 12, 41, 42 (備註2) 輔助回路: 21, 22, 53, 54	有	M20	HSSL-VC7Y4M-G	端子12-41未連接
				HSSL-VC7Y4SM-G (側面電纜引出型)	
VD	門監控回路:2NC 鎖定監控回路:2NC 輔助回路: 11, 12, 41, 42 (備註2) 輔助回路: 21, 22, 51, 52 (備註2)	有	M20	HSSL-VD7Y4M-G	端子12-41未連接
				HSSL-VD7Y4SM-G (側面電纜引出型)	
VF	門監控回路:3NC 鎖定監控回路:1NC 輔助回路: 11, 12, 41, 42 (備註2) 輔助回路: 21, 22, 31, 32	有	M20	HSSL-VF7Y4M-G	端子12-41未連接
				HSSL-VF7Y4SM-G (側面電纜引出型)	
VG	門監控回路:2NC, 1NO 鎖定監控回路:1NC 輔助回路: 11, 12, 41, 42 (備註2) 輔助回路: 21, 22, 33, 34	有	M20	HSSL-VG7Y4M-G	端子12-41未連接
				HSSL-VG7Y4SM-G (側面電纜引出型)	
-	關於HSSE系列的回路編號「H」型， 雖然接點結構稍有不同，請檢討採用 HSSL系列的回路編號「VJ」型。	-	-	-	-
VJ	門監控回路:1NC 鎖定監控回路:2NC, 1NO 輔助回路: 11, 12, 41, 42 (備註2) 輔助回路: 51, 52 (備註2) 輔助回路: 63, 64	有	M20	HSSL-VJ7Y4M-G	端子12-41未連接
				HSSL-VJ7Y4SM-G (側面電纜引出型)	

備註1: 若採用與HSSE型相同回路的話，請務必進行端子間的短路連接。

備註2: 根據ISO14119:2013， 輔助回路接點可單獨做為安全訊號。若採用HSSL型為替代機種時，最終頁的2接點型也請一併參考。

T-2018048附件2【停產品及替代品對照表(詳細)】

· HSE系列 背面鎖定解除按鈕型(彈簧鎖定型) 替代成→ HSSL系列 4接點型、背面鎖定解除按鈕型(彈簧鎖定型) 時

HSE系列 (背面鎖定解除按鈕型、彈簧鎖定型)

回路編號	接點結構	指示燈	電纜長度	訂購型號
A	主回路:1NC+1NC、門監控回路:1NO、鎖定監控回路:1NO 主回路: ① 11, 12, 41, 42 輔助回路: 23, 24, 53, 54 輔助回路:	有	1m	HSSE-A44L01-G
			3m	HSSE-A44L03-G
			5m	HSSE-A44L05-G
C	主回路:1NC+1NC、門監控回路:1NC、鎖定監控回路:1NO 主回路: ① 11, 12, 41, 42 輔助回路: ② 21, 22, 53, 54 輔助回路:	有	1m	HSSE-C44L01-G
			3m	HSSE-C44L03-G
			5m	HSSE-C44L05-G
D	主回路:1NC+1NC、門監控回路:1NC、鎖定監控回路:1NC 主回路: ① 11, 12, 41, 42 輔助回路: ② 21, 22, 51, 52 輔助回路:	有	1m	HSSE-D44L01-G HSSE-D44L01-G-TK2445
			3m	HSSE-D44L03-G
			5m	HSSE-D44L05-G
F	主回路:1NC+1NC、門監控回路:2NC 主回路: ① 11, 12, 41, 42 輔助回路: ② 21, 22, 31, 32 輔助回路:	有	1m	HSSE-F44L01-G
			3m	HSSE-F44L03-G
			5m	HSSE-F44L05-G
G	主回路:1NC+1NC、門監控回路:1NC, 1NO 主回路: ① 11, 12, 41, 42 輔助回路: ② 21, 22, 33, 34 輔助回路:	有	1m	HSSE-G44L01-G
			3m	HSSE-G44L03-G
			5m	HSSE-G44L05-G
G	主回路:1NC+1NC、門監控回路:1NC, 1NO 主回路: ① 11, 12, 41, 42 輔助回路: ② 21, 22, 33, 34 輔助回路:	無	1m	-
			3m	-
			5m	HSSE-G40L05-G-TK2445

替代機種 HSSL系列 (4接點型、背面鎖定解除按鈕型、彈簧鎖定型)

回路編號	接點結構	指示燈	導管口尺寸	訂購型號	備註(1)
VA	門監控回路:1NC, 1NO 鎖定監控回路:1NC, 1NO 輔助回路: ① 11, 12, 41, 42 (備註2) 輔助回路: 23, 24, 53, 54 輔助回路:	有	M20	HSSL-VA44LM-G	端子12-41未連接
VC	門監控回路:2NC 鎖定監控回路:1NC, 1NO 輔助回路: ① 11, 12, 41, 42 (備註2) 輔助回路: ② 21, 22, 53, 54 輔助回路:	有	M20	HSSL-VC44LM-G	端子12-41未連接
VD	門監控回路:2NC 鎖定監控回路:2NC 輔助回路: ① 11, 12, 41, 42 (備註2) 輔助回路: ② 21, 22, 51, 52 (備註2) 輔助回路:	有	M20	HSSL-VD44LM-G HSSL-VD44LSM-G (側面電纜引出型)	端子12-41未連接
VD	門監控回路:2NC 鎖定監控回路:2NC 輔助回路: ① 11, 12, 41, 42 (備註2) 輔助回路: ② 21, 22, 51, 52 (備註2) 輔助回路:	有	M20	HSSL-VD44LM-G HSSL-VD44LSM-G (側面電纜引出型)	端子12-41未連接
VB	門監控回路:1NC、1NO 鎖定監控回路:2NC 輔助回路: ① 11, 12, 41, 42 (備註2) 輔助回路: 23, 24, 51, 52 (備註2) 輔助回路:	有	M20	HSSL-VB44LM-G	端子12-41未連接
VB	門監控回路:1NC、1NO 鎖定監控回路:2NC 輔助回路: ① 11, 12, 41, 42 (備註2) 輔助回路: 23, 24, 51, 52 (備註2) 輔助回路:	有	M20	HSSL-VB44LM-G	-

備註1: 若採用與HSE型相同回路的話, 請務必進行端子間的短路連接。

備註2: 根據ISO14119:2013,  輔助回路接點可單獨做為安全訊號。若採用HSSL型為替代機種時, 最終頁的2接點型也請一併參考。

· HSE系列 安全回路雙重化型(彈簧鎖定型) 替代成→ HSSL系列 4接點型、安全回路雙重化型(彈簧鎖定型) 時

HSE系列 (安全回路雙重化型、彈簧鎖定型)

回路編號	接點結構	指示燈	電纜長度	訂購型號
DD	主回路:1NC+1NC 1NC+1NC 主回路: ① 11, 12, 41, 42 主回路: ② 21, 22, 51, 52 主回路:	有	1m	HSSE-DD4401-G
			3m	HSSE-DD4403-G
			5m	HSSE-DD4405-G
			10m	HSSE-DD4410-G
			15m	HSSE-DD4415-G

替代機種 HSSL系列 (4接點型、安全回路雙重化型、彈簧鎖定型)

回路編號	接點結構	指示燈	導管口尺寸	訂購型號	備註
DD	主回路:1NC+1NC 1NC+1NC 主回路: ① 11, 12, 41, 42 (備註2) 主回路: ② 21, 22, 51, 52 (備註2) 主回路:	有	M20	HSSL-DD44M-G HSSL-DD44SM-G (側面電纜引出型)	-

備註: 根據ISO14119:2013,  輔助回路接點可單獨做為安全訊號。若採用HSSL型為替代機種時, 最終頁的2接點型也請一併參考。

· HSE系列 安全回路雙重化、背面鎖定解除按鈕型(彈簧鎖定型) 替代成→ HSSL系列 4接點型、安全回路雙重化附背面鎖定解除按鈕型(彈簧鎖定型) 時

HSE系列 (安全回路雙重化、背面鎖定解除按鈕型、彈簧鎖定型)

回路編號	接點結構	指示燈	電纜長度	訂購型號
DD	主回路:1NC+1NC 1NC+1NC 主回路: ① 11, 12, 41, 42 主回路: ② 21, 22, 51, 52 主回路:	有	1m	HSSE-DD44L01-G
			3m	HSSE-DD44L03-G
			5m	HSSE-DD44L05-G
			10m	HSSE-DD44L10-G
			15m	HSSE-DD44L15-G

替代機種 HSSL系列 (4接點型、安全回路雙重化附背面鎖定解除按鈕型、彈簧鎖定型)

回路編號	接點結構	指示燈	導管口尺寸	訂購型號	備註
DD	主回路:1NC+1NC 1NC+1NC 主回路: ① 11, 12, 41, 42 (備註2) 主回路: ② 21, 22, 51, 52 (備註2) 主回路:	有	M20	HSSL-DD44LM-G HSSL-DD44LSM-G (側面電纜引出型)	-

備註: 根據ISO14119:2013,  輔助回路接點可單獨做為安全訊號。若採用HSSL型為替代機種時, 最終頁的2接點型也請一併參考。

T-2018048附件2【停產品及替代品對照表(詳細)】

- HSSE系列 4回路獨立輸出型(彈簧鎖定型) 替代成→ HSSL系列 4接點型(彈簧鎖定型) 時

HSSE系列 (4回路獨立輸出型、彈簧鎖定型)

回路編號	接點結構	指示燈	電纜長度	訂購型號
VA	門監控回路:1NC, 1NO 鎖定期監控回路:1NC, 1NO 輔助回路: ⊖ 11, 12 41, 42 輔助回路: 23, 24 53, 54 輔助回路:	有	1m	HSSE-VA4401-G
			3m	HSSE-VA4403-G
			5m	HSSE-VA4405-G
VB	門監控回路:1NC, 1NO 鎖定期監控回路:2NC 輔助回路: ⊖ 11, 12 41, 42 輔助回路: 23, 24 51, 52 輔助回路:	有	1m	HSSE-VB4401-G
			3m	HSSE-VB4403-G
			5m	HSSE-VB4405-G
VC	門監控回路:2NC 鎖定期監控回路:1NC, 1NO 輔助回路: ⊖ 11, 12 41, 42 輔助回路: ⊖ 21, 22 53, 54 輔助回路:	有	1m	HSSE-VC4401-G
			3m	HSSE-VC4403-G
			5m	HSSE-VC4405-G
VD	門監控回路:2NC 鎖定期監控回路:2NC 輔助回路: ⊖ 11, 12 41, 42 輔助回路: ⊖ 21, 22 51, 52 輔助回路:	有	1m	HSSE-VD4401-G
			3m	HSSE-VD4403-G
			4.5m	HSSE-VD44045-G-TK2980
			5m	HSSE-VD4405-G
VF	門監控回路:3NC 鎖定期監控回路:1NC 輔助回路: ⊖ 11, 12 41, 42 輔助回路: ⊖ 21, 22 輔助回路: ⊖ 31, 32	有	1m	HSSE-VF4401-G
			3m	-
			5m	HSSE-VF4405-G

備註: 根據ISO14119:2013,  輔助回路接點可單獨做為安全訊號。若採用HSSL型為替代機種時, 最終頁的2接點型也請一併參考。







- HSSE系列 4回路獨立輸出型(電磁鎖定型) 替代成→ HSSL系列 4接點型(電磁鎖定型) 時

HSSE系列 (4回路獨立輸出型、電磁鎖定型)







回路編號	接點結構	指示燈	電纜長度	訂購型號
VA	門監控回路:1NC, 1NO 鎖定期監控回路:1NC, 1NO 輔助回路: ⊖ 11, 12 41, 42 輔助回路: 23, 24 53, 54 輔助回路:	有	1m	HSSE-VA7Y401-G
			3m	HSSE-VA7Y403-G
			5m	HSSE-VA7Y405-G
VB	門監控回路:1NC, 1NO 鎖定期監控回路:2NC 輔助回路: ⊖ 11, 12 41, 42 輔助回路: 23, 24 51, 52 輔助回路:	有	1m	HSSE-VB7Y401-G
			3m	HSSE-VB7Y403-G
			5m	HSSE-VB7Y405-G
VC	門監控回路:2NC 鎖定期監控回路:1NC, 1NO 輔助回路: ⊖ 11, 12 41, 42 輔助回路: ⊖ 21, 22 53, 54 輔助回路:	有	1m	HSSE-VC7Y401-G
			3m	HSSE-VC7Y403-G
			5m	HSSE-VC7Y405-G
VD	門監控回路:2NC 鎖定期監控回路:2NC 輔助回路: ⊖ 11, 12 41, 42 輔助回路: ⊖ 21, 22 51, 52 輔助回路:	有	1m	HSSE-VD7Y401-G
			3m	HSSE-VD7Y403-G
			5m	HSSE-VD7Y405-G HSSE-VD7Y405-G-TK2686
VF	門監控回路:3NC 鎖定期監控回路:1NC 輔助回路: ⊖ 11, 12 41, 42 輔助回路: ⊖ 21, 22 輔助回路: ⊖ 31, 32	有	1m	HSSE-VF7Y401-G
			3m	HSSE-VF7Y403-G
			5m	-

備註: 根據ISO14119:2013,  輔助回路接點可單獨做為安全訊號。若採用HSSL型為替代機種時, 最終頁的2接點型也請一併參考。

替代機種 HSSL系列 (4接點型、彈簧鎖定型)

回路編號	接點結構	指示燈	導管口尺寸	訂購型號	備註
VA	門監控回路:1NC, 1NO 鎖定期監控回路:1NC, 1NO 輔助回路: ⊖ 11, 12 41, 42  (備註2) 輔助回路: 23, 24 53, 54	有	M20	HSSSL-VA44M-G	-
				HSSSL-VA44SM-G (側面電纜引出型)	-
				HSSSL-VA44M-G	-
VB	門監控回路:1NC, 1NO 鎖定期監控回路:2NC 輔助回路: ⊖ 11, 12 41, 42  (備註2) 輔助回路: 23, 24 51, 52  (備註2) 輔助回路:	有	M20	HSSSL-VB44M-G	-
				HSSSL-VB44M-G	-
				HSSSL-VB44M-G	-
VC	門監控回路:2NC 鎖定期監控回路:1NC, 1NO 輔助回路: ⊖ 11, 12 41, 42  (備註2) 輔助回路: ⊖ 21, 22 53, 54	有	M20	HSSSL-VC44M-G	-
				HSSSL-VC44M-G	-
				HSSSL-VC44M-G	-
VD	門監控回路:2NC 鎖定期監控回路:2NC 輔助回路: ⊖ 11, 12 41, 42  (備註2) 輔助回路: ⊖ 21, 22 51, 52  (備註2) 輔助回路:	有	M20	HSSSL-VD44M-G	-
				HSSSL-VD44SM-G (側面電纜引出型)	-
				HSSSL-VD44M-G	-
VF	門監控回路:3NC 鎖定期監控回路:1NC 輔助回路: ⊖ 11, 12 41, 42  (備註2) 輔助回路: ⊖ 21, 22 輔助回路: ⊖ 31, 32	有	M20	HSSSL-VF44M-G	-
				HSSSL-VF44M-G	-
				HSSSL-VF44M-G	-

替代機種 HSSL系列 (4接點型、電磁鎖定型)

回路編號	接點結構	指示燈	導管口尺寸	訂購型號	備註
VA	門監控回路:1NC, 1NO 鎖定期監控回路:1NC, 1NO 輔助回路: ⊖ 11, 12 41, 42  (備註2) 輔助回路: 23, 24 53, 54	有	M20	HSSSL-VA7Y4M-G	-
				HSSSL-VA7Y4SM-G (側面電纜引出型)	-
				HSSSL-VA7Y4M-G	-
VB	門監控回路:1NC, 1NO 鎖定期監控回路:2NC 輔助回路: ⊖ 11, 12 41, 42  (備註2) 輔助回路: 23, 24 51, 52  (備註2) 輔助回路:	有	M20	HSSSL-VB7Y4M-G	-
				HSSSL-VB7Y4M-G	-
				HSSSL-VB7Y4M-G	-
VC	門監控回路:2NC 鎖定期監控回路:1NC, 1NO 輔助回路: ⊖ 11, 12 41, 42  (備註2) 輔助回路: ⊖ 21, 22 53, 54	有	M20	HSSSL-VC7Y4M-G	-
				HSSSL-VC7Y4SM-G (側面電纜引出型)	-
				HSSSL-VC7Y4M-G	-
VD	門監控回路:2NC 鎖定期監控回路:2NC 輔助回路: ⊖ 11, 12 41, 42  (備註2) 輔助回路: ⊖ 21, 22 51, 52  (備註2) 輔助回路:	有	M20	HSSSL-VD7Y4M-G	-
				HSSSL-VD7Y4M-G	-
				HSSSL-VD7Y4M-G	-
VF	門監控回路:3NC 鎖定期監控回路:1NC 輔助回路: ⊖ 11, 12 41, 42  (備註2) 輔助回路: ⊖ 21, 22 輔助回路: ⊖ 31, 32	有	M20	HSSSL-VF7Y4M-G	-
				HSSSL-VF7Y4M-G	-
				HSSSL-VF7Y4M-G	-

■T-2018048附件2【停產品及替代品對照表(詳細)】

• HSSE系列(彈簧鎖定型)替代成→ HSSL系列 2接點型(彈簧鎖定型)時

HSSL系列 (2接點型、彈簧鎖定型)

回路編號	接點結構	指示燈	導管口尺寸	訂購型號	備註
XD	門監控回路:1NC 鎖定期監控回路:1NC 輔助回路: 11, 12 輔助回路: 41, 42 (備註)	有	M20	HSSL-XD44M-G	-
XH	門監控回路:2NC 輔助回路: 41, 42 (備註) 輔助回路: 51, 52 (備註)	有	M20	HSSL-XH44M-G HSSL-XH44LM-G (背面鎖定解除按鈕型)	-

備註: 根據ISO14119:2013,  輔助回路接點可單獨做為安全訊號。

• HSSE系列(電磁鎖定型)替代成→ HSSL系列 2接點型(電磁鎖定型)時

HSSL系列 (2接點型、電磁鎖定型)

回路編號	接點結構	指示燈	導管口尺寸	訂購型號	備註
XD	門監控回路:1NC 鎖定期監控回路:1NC 輔助回路: 11, 12 輔助回路: 41, 42 (備註)	有	M20	HSSL-XD7Y4M-G	-
XF	門監控回路:2NC 輔助回路: 11, 12 輔助回路: 21, 22	有	M20	HSSL-XF7Y4M-G	-
XG	門監控回路:1NC, 1NO 輔助回路: 11, 12 輔助回路: 23, 24	有	M20	HSSL-XG7Y4M-G	-
XH	門監控回路:2NC 輔助回路: 41, 42 (備註) 輔助回路: 51, 52 (備註)	有	M20	HSSL-XH7Y4M-G	-

備註: 根據ISO14119:2013,  輔助回路接點可單獨做為安全訊號。